



User Manual

Version 1.0.0 June 2020

DL-100TMS-ZT

(ZigBee Temperature and Humidity Module)



Written by Bernie Wu

Edited by Kalia Huang

Table of Contents

1. Introduction	4
1.1 Introduction to ZigBee	4
1.2 Introduction to DL-100TMS-ZT	4
1.3 Features	5
2. Information to the Hardware	6
2.1 Specifications	6
2.2 Pin Assignments	8
2.3 Block Diagram	8
2.4 Wire Connections	9
3. Setting up the DL-100TMS-ZT	10
3.1 Introduction to the Configuration Parameters	10
3.2 Starting the DL-100TM-ZT	11
3.3 Default parameter	11
3.4 An overview of the utility	12
3.5 Connecting to the DL-100TMS-ZT Module	13
3.6 Retrieving Records	14
3.7 Configuration	15
4. Modbus RTU Command Set	16
4.1 How to communication with DL-100TMS-ZT	16
4.2 The Modbus RTU Protocol Command Set	16
4.2.1 Overview the Modbus Command Sets	17
5. Troubleshooting	20
6. Appendix A	21
6.1 LCD Information	21
7. Appendix B. Revision History	23

Important Information

Warranty

All products manufactured by ICP DAS are under warranty regarding defective materials for a period of one year, beginning from the date of delivery to the original purchaser.

Warning

ICP DAS assumes no liability for any damage resulting from the use of this product. ICP DAS reserves the right to change this manual at any time without notice. The information furnished by ICP DAS is believed to be accurate and reliable. However, no responsibility is assumed by ICP DAS for its use, not for any infringements of patents or other rights of third parties resulting from its use.

Copyright

Copyright © 2019 by ICP DAS Co., Ltd. All rights are reserved.

Trademark

Names are used for identification purpose only and may be registered trademarks of their respective companies.

Contact us

If you encounter any problems while operating this device, feel free to contact us via mail at: service@icpdas.com . We guarantee to respond within 2 working days.

1. Introduction

1.1 Introduction to ZigBee

ZigBee is a specification for a suite of high-level communication protocols using small, low-power digital radios based on the IEEE 802.15.4 standard for personal area networks. ZigBee devices are often used in mesh network form to transmit data over longer distances, passing data through intermediate devices to reach more distant ones. This allows ZigBee networks to be formed ad-hoc, with no centralized control or high-power transmitter/receiver able to reach all of the devices. Any ZigBee device can be tasked with running the network.

ZigBee is targeted at applications that require a low data rate, long battery life, and secure networking. ZigBee has a defined rate of 250 kbit/s, best suited for periodic or intermittent data transmission or a single signal transmission from a sensor or input device. Applications include wireless light switches, electrical meters with in-home-displays, traffic management systems, and other consumer and industrial equipment that requires short-range wireless transfer of data at relatively low rates. The technology defined by the ZigBee specification is intended to be simpler and less expensive than other WPANs.

1.2 Introduction to DL-100TMS-ZT

The DL-100TMS-ZT is a one-channel temperature and humidity data logger module. It contains a ZigBee communication interface and an LCM to display the module ID, temperature and humidity data, and allows you define the log time interval depending on your application.

The DL-100TMS-ZT supports the Modbus RTU protocol. Refer to Section 4 for more details. We also provide software Utility that can be used to retrieve log data and display it in a chart on your desktop, and also allow you save the log data into an Excel format file.

1.3 Features

- ◆ Measurement Ranges: -20 ~ +60°C and 0 ~ 100% RH
- ◆ Accuracy: +/-0.4°C; +/-2.0% RH
- ◆ LCD Display Shows Temperature, Humidity and Module ID
- ◆ 10 ~ 30 VDC Power Input
- ◆ IP66 Waterproof
- ◆ Data Logger Can Store Up to 510 Temperature and Humidity Records
- ◆ Modbus RTU Protocol
- ◆ ISM 2.4 GHz Operating Frequency
- ◆ Fully Compliant with 2.4G IEEE 802.15.4 / ZigBee 2007 Pro Specifications
- ◆ Wireless Transmission Range up to 100 m
- ◆ GUI Configuration Software (Windows Version)
- ◆ Supports AES-128 Encryption for the Wireless Communication (Passive)
- ◆ Supports ZigBee Repeater Function
- ◆ Surge and ESD Protection

2. Information to the Hardware

2.1 Specifications

Models	DL-100TMS-ZT
RF	
Wireless Standards	ZigBee 2007 Pro
Transmission Power	11dBm (Max. 19dBm)
Antenna	2.4 GHz - PCB Antenna (3dBi, 50Ω)
Transmission Range(LOS)	100m
Protocols	Supports Modbus RTU
Humidity Sensor	
Measurement Range	0 ~ 100% RH (Relative Humidity)
Resolution	0.1% RH
Accuracy	Typical: ±2% RH
	Max.: Refer to Figure 1
Precision	±0.1% RH
Temperature Sensor	
Measurement Range	-20 ~ +60 °C
Resolution	0.1 °C
Accuracy	Typical: ±0.4 °C
	Max.: Refer to Figure 2
Precision	±0.1 °C
EMS Protection	
ESD (IEC 61000-4-2)	±4 kV Contact for each Terminal
EFT (IEC 61000-4-4)	±1 kV for Power
Power	
Input Range	+10 VDC ~ +30 VDC
Power Consumption	0.5 W Max.
Mechanical	
Dimensions (W x L x H)	82mm x 172mm x 55mm
Environment	
Operating Temperature	-20 ~ +60 °C
Storage Temperature	-25 ~ +75 °C
Ambient Relative Humidity	10 ~ 95% RH(Non-condensing)

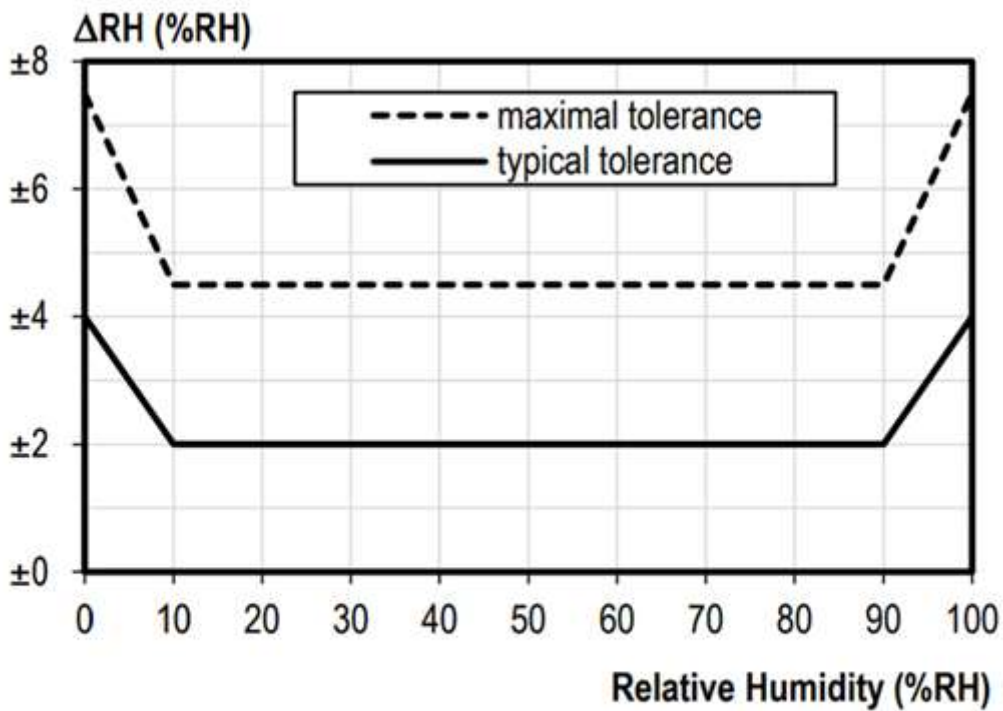

Figure 1 : Tolerance of RH at 25°C for DL-100TMS-ZT

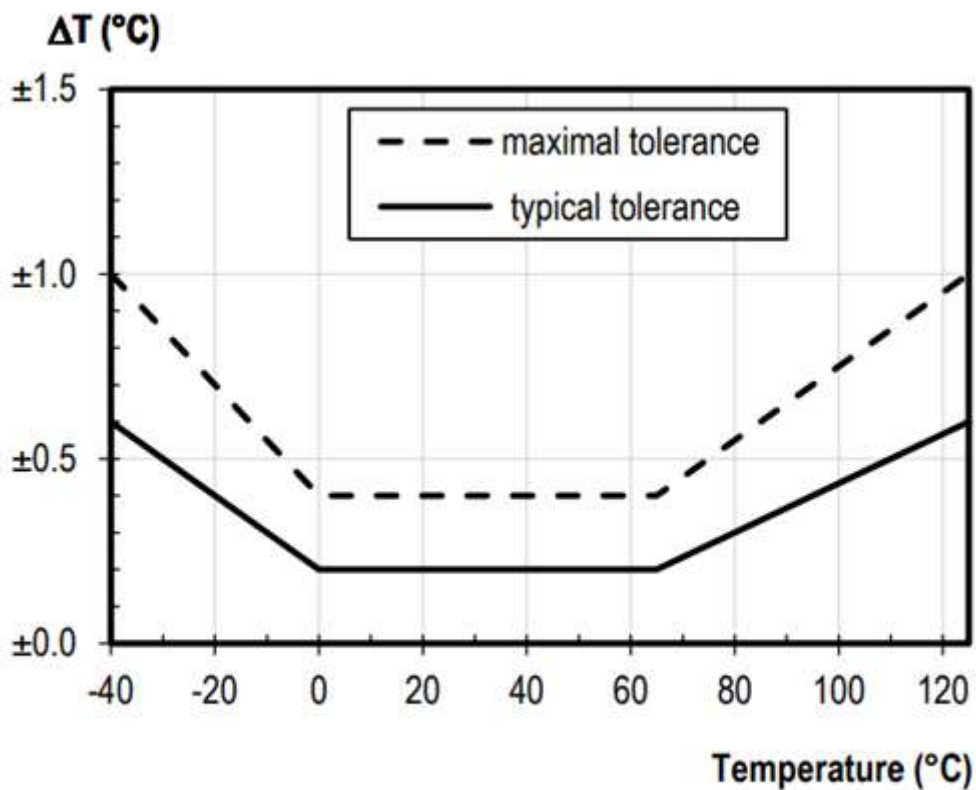
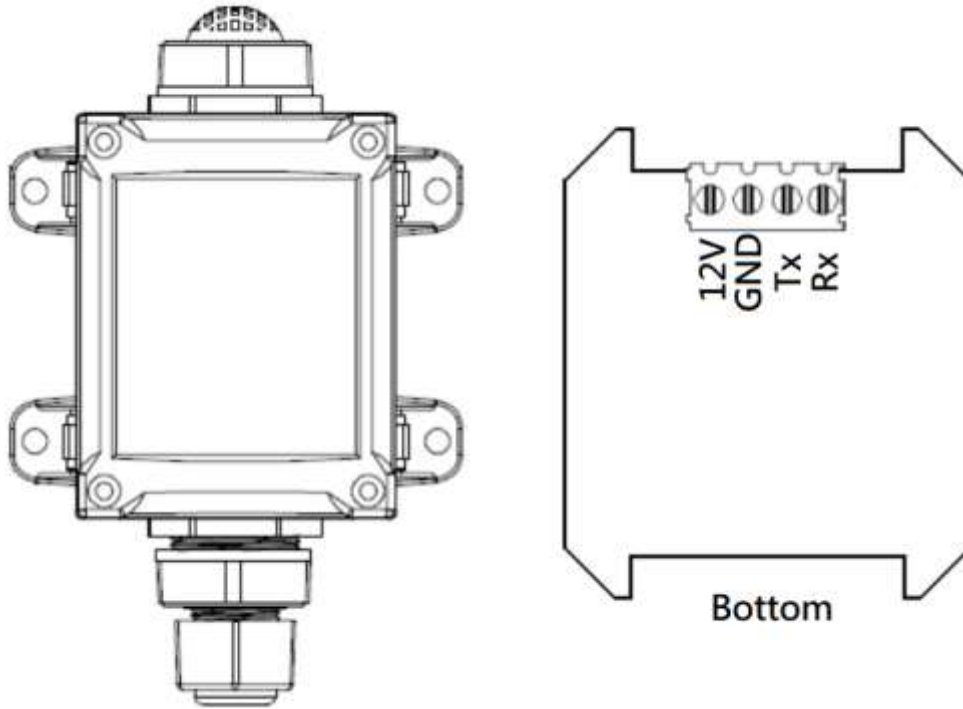
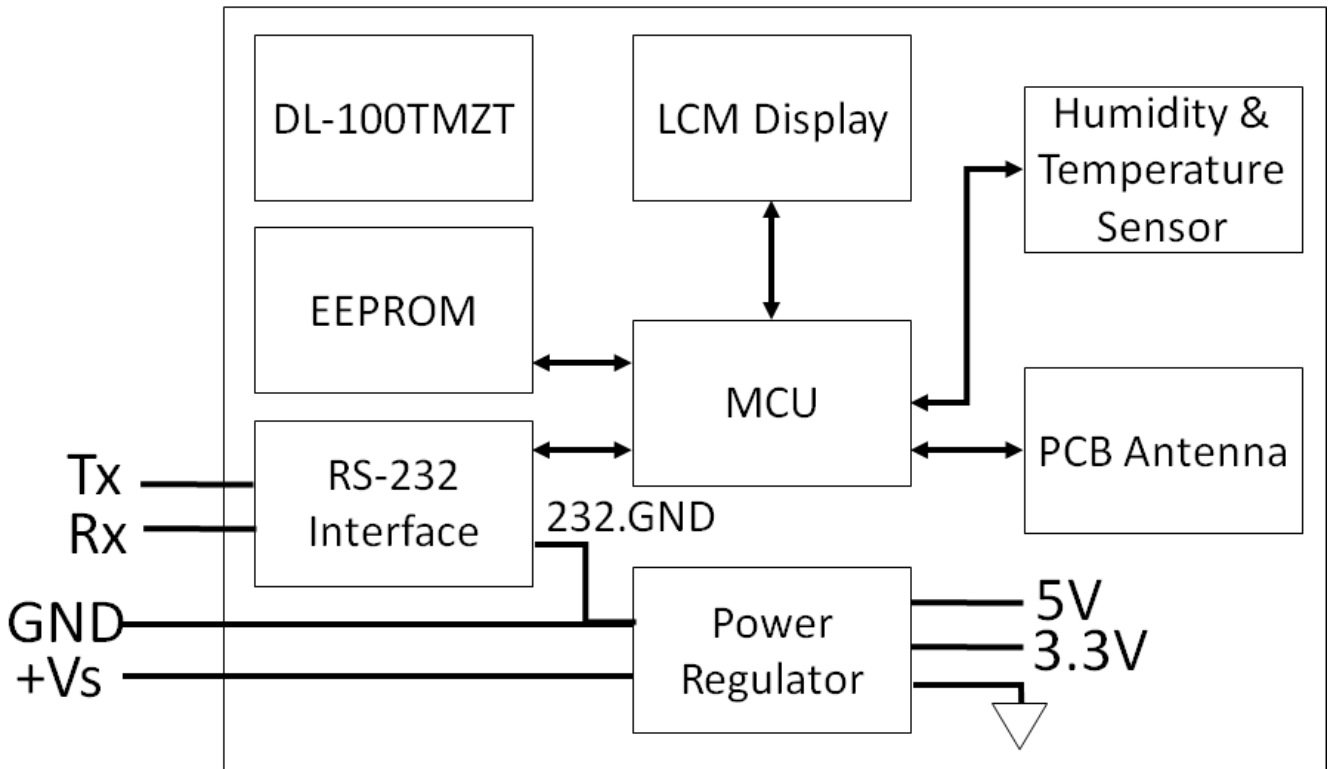

Figure 2 : Temperature accuracy of DL-100TMS-ZT

2.2 Pin Assignments



2.3 Block Diagram



2.4 Wire Connections

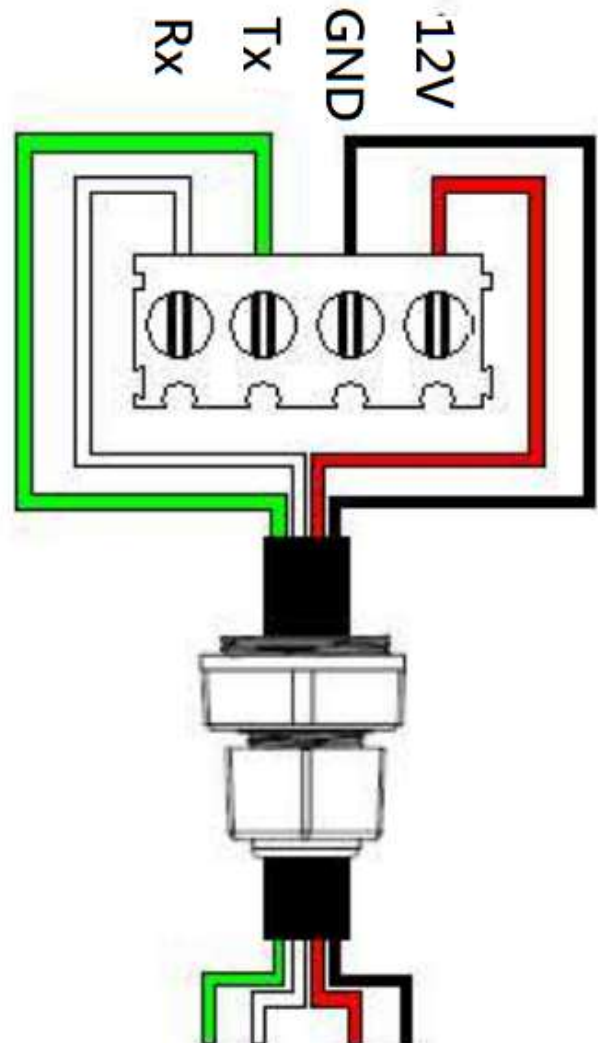
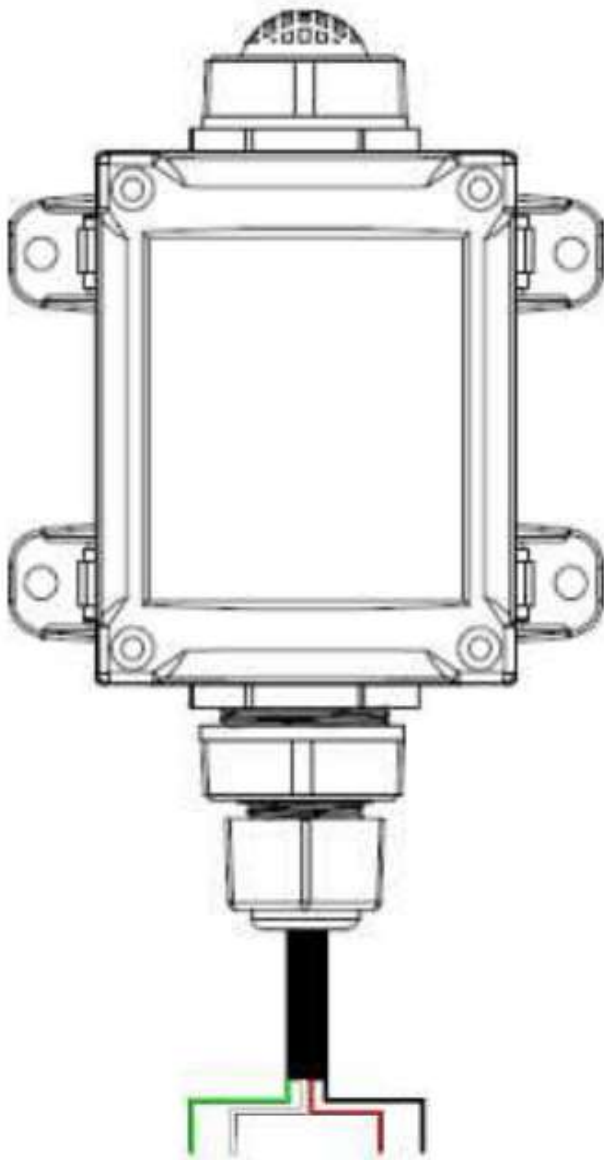

3. Setting up the DL-100TMS-ZT

3.1 Introduction to the Configuration Parameters

- i. Pan ID : parameter is the group identity for a ZigBee network, and must the same for all devices in the same ZigBee network.

(DL-100TMS-ZT module use range : 0x0000~0x3FFF)

- ii. Address / Node ID : parameter is the undivided identity of a specific the ZigBee module, and must be unique for each device connected the same ZigBee network.

(DL-100TMS-ZT module use range : 0x01~0xFF)

- iii. RF Channel : parameter indicates the radio frequency channel, and must be set to the same value as other modules on the same ZigBee network.

Channel	0x00	0x01	0x0F
Frequency (MHz)	2405	2410	2480

※ RF channels 0x04, 0x09, 0x0E or 0x0F are recommended because they do not overlap with the Wi-Fi frequencies based.

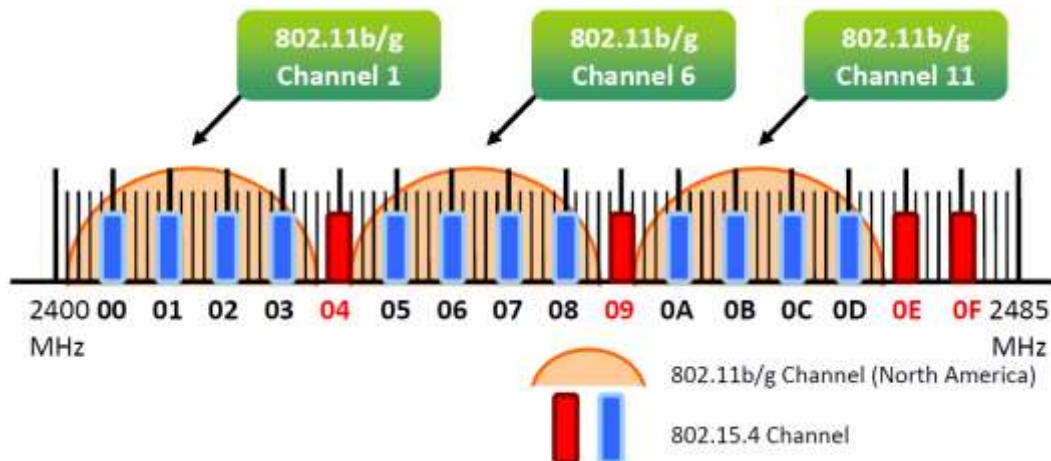

3.2 Starting the DL-100TM-ZT

As the ZigBee network is controlled by the ZigBee coordinator, the ZT-2550/ZT-2570 (ZigBee coordinator) must be configured first. Please refer to documents shown below for full details of how to configure these devices.

Once configuration of the ZigBee coordinator has been completed. Set the "Pan ID" and the "RF Channel" values for the DL-100TM-ZT to the same values as the network, and then reboot the device. The module will automatically start to function on the ZigBee network using the default protocol.

Documents

http://ftp.icpdas.com.tw/pub/cd/usbcd/napdos/zigbee/zt_series/document/zt-255x/

http://ftp.icpdas.com.tw/pub/cd/usbcd/napdos/zigbee/zt_series/document/zt-257x/

Configuration Utility (Used to configure ZT-25xx device Coordinator)

http://ftp.icpdas.com.tw/pub/cd/usbcd/napdos/zigbee/zt_series/utility/

3.3 Default parameter

The DL-100TMS-ZT has a default wireless parameter values in first mode. You can connect the module through the following parameter.

(If you don't want to change existing ZigBee Coordinator settings, you can connect via RS-232)

Protocol	Modbus
Checksum	Enable
PAN ID	0x0001
Node ID	0x01
RF Channel	0x00
RF Power	0x07

3.4 An overview of the utility

Once the DL-100TMS-ZT has joined the ZigBee network, the signal quality can be confirmed by monitoring the status of the ZigBee indicators on the LCM Display.





ICP DAS also provides the “DL-100TMS-ZT Utility”, which can be used to simulate Modbus communication. This software can also be used to verify the device settings.

※ The DL-100TMS-ZT Utility can be download from:

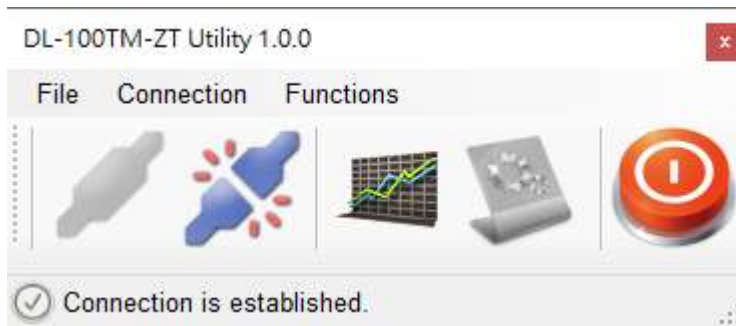
http://ftp.icpdas.com/pub/cd/8000cd/napdos/driver/dcon_utility/

※ After launching the Utility, the program interface will be displayed, as shown below:



- Clicking either the “Connection->Connect->RS-232/RS-485” menu option or the  icon will create a connection from the serial port.
- Clicking either the “Connection->Disconnect” menu option or the  icon will disconnect the connection between the PC and the DL-100TMS-ZT.
- Clicking either the “Functions->Get Records” menu option or the  icon will retrieve the log data which is stored on the DL-100TMS-ZT.
- Clicking either the “Functions->Configuration” menu option or the  icon will allow the DL-100TMS-ZT to be configured.
- Clicking either the “File->Exit” menu option or the  icon will close the Utility software.

3.5 Connecting to the DL-100TMS-ZT Module

1. Clicking either the “Connection->Connect->RS-232/RS-485” menu option or the “” button will open the connection selection menu, as shown below:

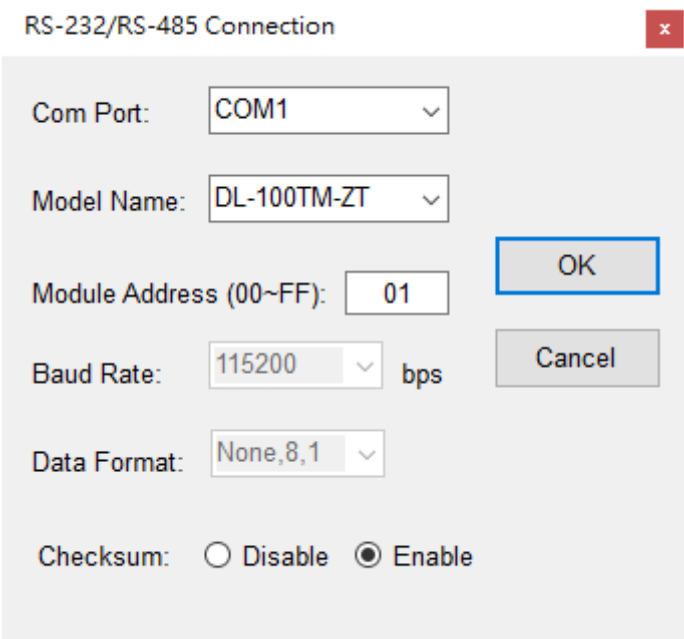

RS-232/RS-485 Connection

Com Port: COM1

Model Name: DL-100TM-ZT

Module Address (00~FF): 01





Baud Rate: 115200 bps

Data Format: None,8,1

Checksum: Disable Enable

OK

Cancel

2. Select your COM port number and set the Model Name selection to the DL-100TMS-ZT. If you are connecting to a new module, the default address will be 01. Click the “OK” button to connect to the DL-100TMS-ZT. **Note: The LCD will also indicate the module address.**
3. If a connection is successfully established, the Utility will return to the previous window and the message “Connection is established” will be displayed in the status bar. The “” and “” icons will also become available.
4. If you want retrieve records that are stored on the DL-100TMS-ZT, click either the “” icon or the “Functions->Get Records” menu option .
5. If you want to configure the DL-100TMS-ZT, either click the “” icon or “Functions->Configuration” menuoption.

3.6 Retrieving Records

After a connection has been established between the PC and the DL-100TMS-ZT, you can retrieve log data via the Utility software. The procedure is as follows:

1. Either click the *‘‘Functions->Get Records’’ menu option or the  icon and the ‘‘Load Log Data’’ window will be displayed.
2. Click the ‘‘Get’’ button and wait until the data is successfully received.

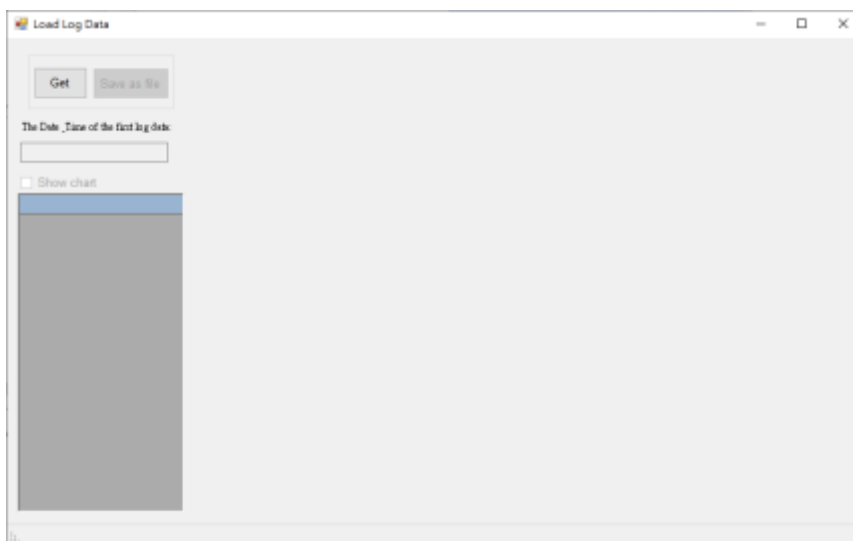

3. Press Show chart to draw the chart.



3.7 Configuration

1. After a connection has been established between the PC and the DL-100TMS-ZT, the DL-100TMS-ZT can be configured by either clicking the “” icon or the ***“Functions->Configuration”** menu option. The “Configuration” window will then be displayed showing the current configuration of the module. If any of the values are changed, click the “Set” button to update the configuration of the module.



2. When you successfully connect to the DL-100TMS-ZT using the Utility software, the software will automatically disable the data log function. If the data log function is required, ensure that the data log function is enabled before closing the Utility software.

4. Modbus RTU Command Set

4.1 How to communication with DL-100TMS-ZT

DL-100TMS-ZT can operate using Modbus RTU protocol, and we also provide software Utility that can be used to retrieve log data and display it in a chart on your desktop allow you save the log data into an Excel format file.

4.2 The Modbus RTU Protocol Command Set

➤ Modbus RTU Command Format

Field 1	Field 2	Field 3	Field 4~n	Field n+1~n+2
Module Address	Function Code	Sub function	Configuration field	CRC16

Function Code	Description	Address
0x01	Read coils	0xxxx
0x02	Read discrete inputs	1xxxx
0x03	Read multiple registers	4xxxx
0x04	Read multiple input registers	3xxxx
0x05	Write single coils	0xxxx
0x06	Write single registers	4xxxx
0x0F	Write multiple coils	0xxxx
0x10	Write multiple registers	4xxxx

If the function specified in the message is not supported, then the module responds as follows.

Number	Description	Length	Value
00	Address	1 Byte	1~247
01	Function code	1 Byte	Function code+0x80
02	Exception code	1 Byte	01

If a CRC mismatch occurs, the module will not respond.

4.2.1 Overview the Modbus Command Sets

Address (base1)	Address (base0) (Dec/Hex)	Function Code(s)	Access	Data Type	Name	Comments
00257	256 (0x100)	01, 02 05, 15	R/W	Bit	Enables or disables the logging Function	0: Disabled 1: Enabled
00258	257 (0x101)	01, 02 05, 15	R/W	Bit	Resets the value of the log records counter to 0	Set this bit to 1 to clear the log data counter value. This bit will be set to 0 when clean successfully.
10260	259 (0x103)	01, 02	R	Bit	Reset Bit	This bit only returns a value of 1 when you read it for the first time. In all other cases, it always returns a value of 0.

Address (base1)	Address (base0) (Dec/Hex)	Function Code(s)	Access	Data Type	Name	Comments
30001	0 (0)	03, 04	R	Word	Humidity value	The response value is the result of the original value multiplied by 100.
30002	1 (1)	03, 04	R	Word	Temperature value in degrees Celsius	
30003	2 (2)	03, 04	R	Word	Temperature value in degrees Fahrenheit	
30503	502 (01F6)	03, 04, 06	R/W	Word	RF Power Value	Wireless power value.
365521	65520 (FFF0)	03, 04	R	Word	Firmware version	High byte: major version Low byte: minor version
365522	65521 (FFF1)	03, 04	R	Long HI	Module Name	High byte: 'D', Low byte: 'L'
365523	65522 (FFF2)	03, 04	R	Long LO		High byte: 'Z', Low byte: 'T'
365524	65523 (FFF3)	03, 04	R	Word	The number of log records	-

Table1

Value	Interval	Value	Interval	Value	Interval	Value	Interval
0	10S	3	1M	6	30M	9	6H
1	20S	4	5M	7	1H	0x0A	12H
2	30S	5	10M	8	2H	0x0B	1D

Address (base1)	Address (base0) (Dec/Hex)	Function Code(s)	Access	Data Type	Name	Comments
365525	65524 (0xFFF4)	03, 04, 06, 16	R/W	Byte	High byte: Module address	1~248
				Bit	Low byte: Logging mode	0: The module will stop logging if the EEPROM memory is full. 1: The earliest stored data record will be overwritten if the EEPROM memory is full.
365526	65525 (0xFFF5)	03, 04, 06, 16	R/W	Byte	High byte: LCD display mode	00~7F
					Low byte: Logging interval	The allowed range is from 0 to 0x0B. Refer to Table 1 for more information.
365528	65526 (0xFFF6)	03, 04, 06, 16	R/W	Sign Byte	High byte: Module baud rate	00: 115200 bps
					Low byte: Temperature offset value	The unit is 0.1 degrees in Celsius, the range is from -12.8°C ~ 12.7°C.
365528	65527 (0xFFF7)	03, 04, 06	R/W	Word	Pan ID	0x0000~0x3FFF
365529	65528 (0xFFF8)	03, 04, 06	R/W	Word	Channel ID	0x00~0x0F

Address (base1)	Address (base0) (Dec/Hex)	Function Code(s)	Access	Data Type	Name	Comments
365530	65529 (0xFFFF9)	03, 04 06, 16	R/W	Word	The base year and month values.	High byte: year Low byte: month
365531	65530 (0xFFFFA)	03, 04 06, 16	R/W	Word	The base day and hour values.	High byte: day Low byte: hour
365532	65531 (0xFFFFB)	03, 04 06, 16	R/W	Word	The base minutes and seconds values.	High byte: minutes Low byte: seconds
365533	65522 (0xFFFFC)	03, 04	R	Word	The current year and month values.	High byte: current year Low byte: current month
365534	65533 (0xFFFFD)	03, 04	R	Word	The current day and hour values.	High byte: current day Low byte: current hour
365535	65534 (0xFFFFE)	03, 04	R	Word	The current minute and second values.	High byte: current minute Low byte: current second

5. Troubleshooting

(1) Technical Support.

If you have any difficulties using your DL-100TMS-ZT, please send a description of the problem to service@icpdas.com

Include the following items in your email:

- A copy of the configuration file for the coordinator. This file can be obtained using the procedure outlined below and should be attached to your email.
- a. Set the DIP switch of the ZT-25xx device to the [ZBSET] position then reboot the device. Launch the ZT Configuration Utility and select [Save Log] icon to save the configuration of the ZT-25xx as a file.



After clicking the [Save Log] icon, enter the "File Name" and the "File Path" in the Windows "Save" dialog box. Once the configuration has been successfully saved, the following message will be displayed.

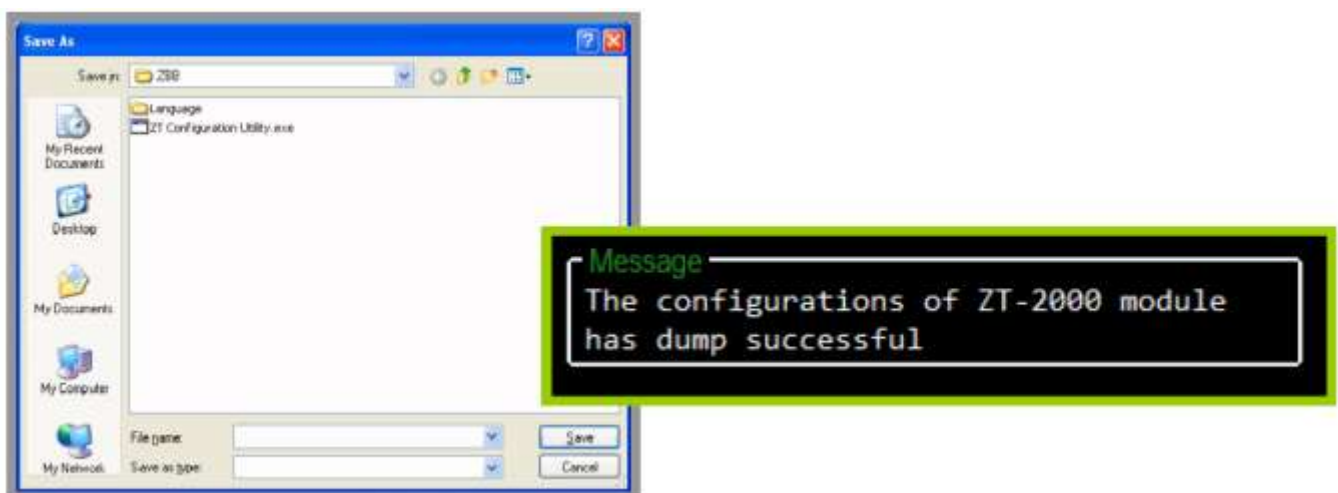

6. Appendix A

6.1 LCD Information

- **Module Address:**

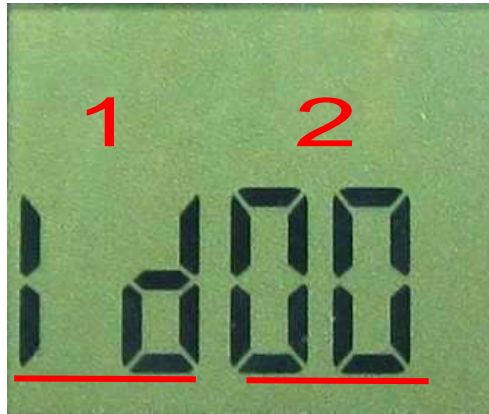

Area	LCD value	Details
1	ID/CH/PD	Indicates that the currently displayed information is the module address/Channel number/Pan ID.
2	00~FF	Indicates the current module address.

- **Temperature Value:**

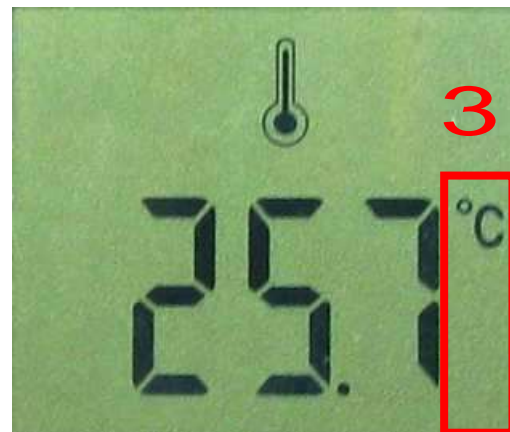
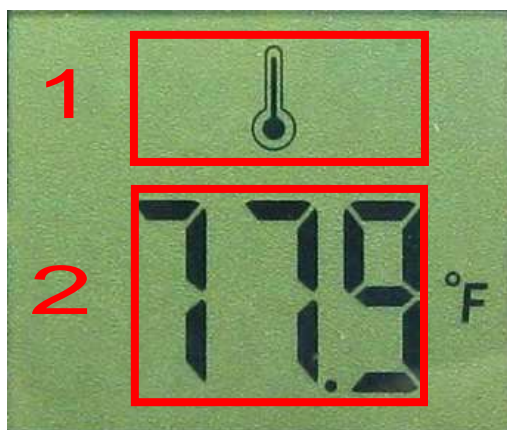

Area	LCD value	Details
1	icon	Indicates that the currently displayed information is the temperature.
2	DDD.D~-DD.D	Indicates the current temperature value.
3	°C or °F icon	Indicates the temperature units.

● **Humidity Value:**

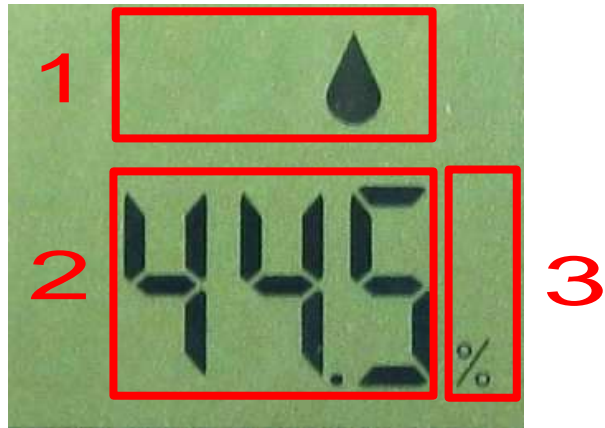

Area	LCD value	Details
1	icon	Indicates that the currently displayed information is the humidity.
2	DD.D	Indicates the current humidity value.
3	% icon	Indicates the humidity units.

7. Appendix B. Revision History

This chapter provides revision history information to this document.

The table below shows the revision history.

Revision	Date	Description
1.0.0	June 2020	Initial issue(Written by Bernie Wu)